

L:
 CBL-HFPD3igMB-1m 1000mm±20mm
 CBL-HFPD3igMB-2m 2000mm±20mm
 CBL-HFPD3igMB-3m 3000mm±20mm

No	MATERIALS LIST:
1.	CABLE:UL20236 (2x(2x28AWG)+2x(2x28AWG)C) OD:7.0mm PUR JACKET COLOR:RED LILAC
2.	CONNECTOR:USB 3.0 A/M, 9P, BLUE INSULATOR SOLDER TYPE, NICKEL PLATED SHELL
3.	CONNECTOR:USB 3.0 MicroB/M, 10P, BLACK INSULATOR SOLDER TYPE, NICKEL PLATED SHELL
4.	ABS ASSEMBLY HOUSING, BLACK COLOR

PIN OUT	
USB A(M)	USB MicroB(M)
1 ———	RED ——— 1
2 ———	WHITE ——— 2
3 ———	GREEN ——— 3
4 ———	BLACK ——— 5
5 ———	BLUE ——— 6
6 ———	YELLOW ——— 7
7 ———	DRAIN WIRE ——— 8
8 ———	PURPLE ——— 9
9 ———	ORANGE ——— 10
SHELL ———	BRAID ——— SHELL

Jargy part no.	Client part no.	Approved	SCALE	UNIT
CBL-HFPD3igMB-xm				mm
Drawing Name		Drawn	Date	REV.
USB 3.0 A to Micro-B Cable M/M				1.0

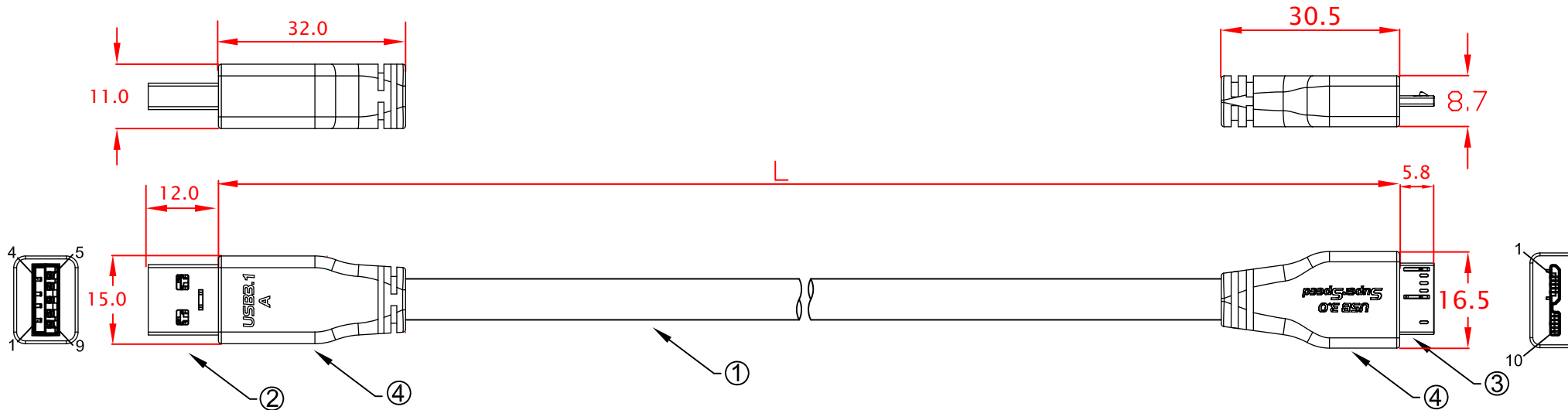

L:
 CBL-HFPD3igMB-1m 1000mm±20mm
 CBL-HFPD3igMB-2m 2000mm±20mm
 CBL-HFPD3igMB-3m 3000mm±20mm

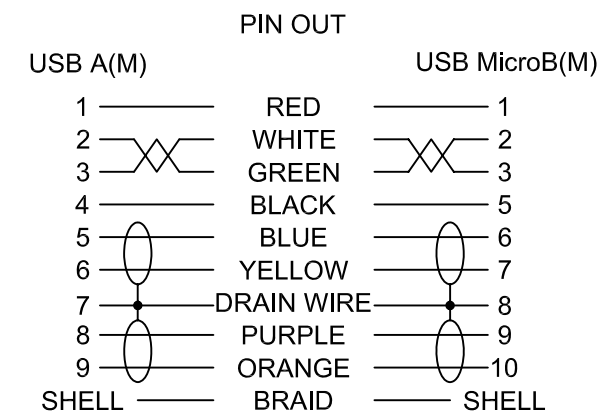

No	MATERIALS LIST:
1.	CABLE:UL20236 (2x(2x28AWG)+2x(2x28AWG)C) OD:7.0mm PUR JACKET COLOR:RED LILAC
2.	CONNECTOR:USB 3.0 A/M, 9P, BLUE INSULATOR SOLDER TYPE, NICKEL PLATED SHELL
3.	CONNECTOR:USB 3.0 MicroB/M, 10P, BLACK INSULATOR SOLDER TYPE, NICKEL PLATED SHELL
4.	PVC MOLDED HOUSING, BLACK COLOR

Jargy part no.	Client part no.	Approved	SCALE	UNIT
CBL-HFPD3igMB-xm				mm
Drawing Name		Drawn	Date	REV.
USB 3.0 A to MicroB Cable M/M				1.0

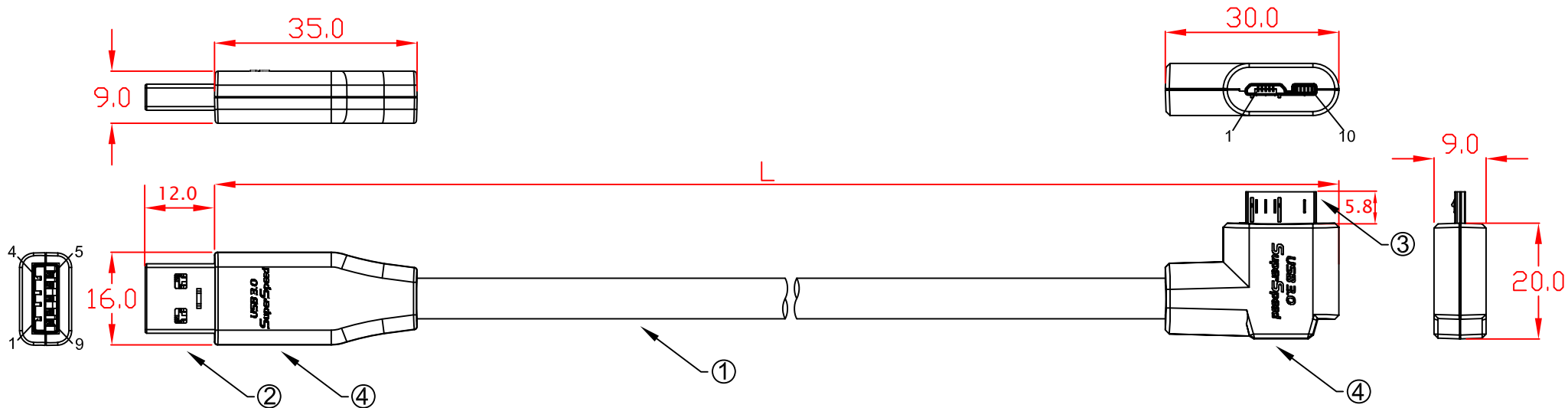

L:
 CBL-HFPD3igMB-1mLA 1000mm±20mm
 CBL-HFPD3igMB-2mLA 2000mm±20mm
 CBL-HFPD3igMB-3mLA 3000mm±20mm

PIN OUT	
USB A(M)	USB MicroB(M)
1 ———	RED ——— 1
2 ———	WHITE ——— 2
3 ———	GREEN ——— 3
4 ———	BLACK ——— 5
5 ———	BLUE ——— 6
6 ———	YELLOW ——— 7
7 ———	DRAIN WIRE ——— 8
8 ———	PURPLE ——— 9
9 ———	ORANGE ——— 10
SHELL ———	BRAID ——— SHELL

No	MATERIALS LIST:
1.	CABLE:UL20236 (2x(2x28AWG)+2x(2x28AWG)C) OD:7.0mm PUR JACKET COLOR:RED LILAC
2.	CONNECTOR:USB 3.0 A/M, 9P, BLUE INSULATOR SOLDER TYPE, NICKEL PLATED SHELL
3.	CONNECTOR:USB 3.0 MicroB/M, 10P, BLACK INSULATOR SOLDER TYPE, NICKEL PLATED SHELL
4.	ABS ASSEMBLY HOUSING, BLACK COLOR

Jargy part no.	Client part no.	Approved	SCALE	UNIT
CBL-HFPD3igMB-xmLA				mm
Drawing Name		Drawn	Date	REV.
USB 3.0 A to MicroB Cable M/M				1.0

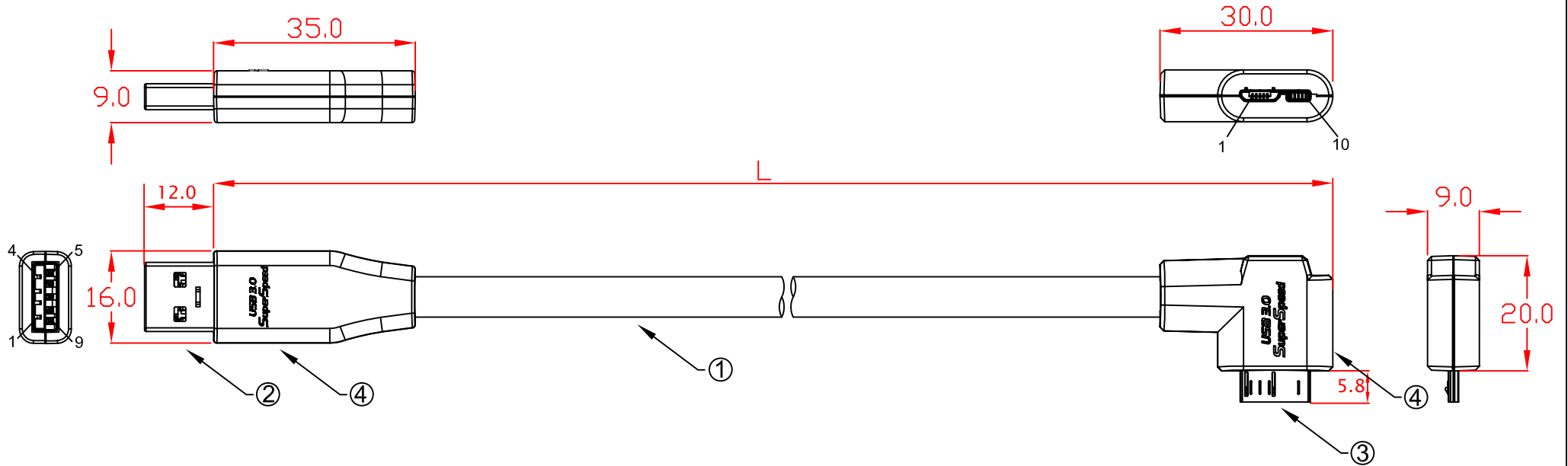

L:
 CBL-HFPD3igMB-1mRA 1000mm±20mm
 CBL-HFPD3igMB-2mRA 2000mm±20mm
 CBL-HFPD3igMB-3mRA 3000mm±20mm

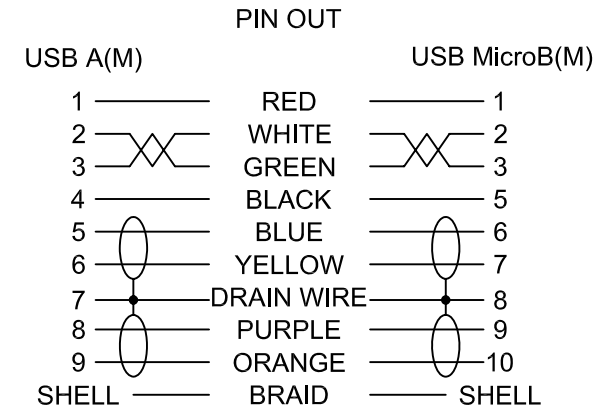

No	MATERIALS LIST:
1.	CABLE:UL20236 (2x(2x28AWG)+2x(2x28AWG)C) OD:7.0mm PUR JACKET COLOR:RED LILAC
2.	CONNECTOR:USB 3.0 A/M, 9P, BLUE INSULATOR SOLDER TYPE, NICKEL PLATED SHELL
3.	CONNECTOR:USB 3.0 MicroB/M, 10P, BLACK INSULATOR SOLDER TYPE, NICKEL PLATED SHELL
4.	ABS ASSEMBLY HOUSING, BLACK COLOR

Jargy part no.	Client part no.	Approved	SCALE	UNIT
CBL-HFPD3igMB-xmRA				mm
Drawing Name		Drawn	Date	REV.
USB 3.0 A to MicroB Cable M/M				1.0

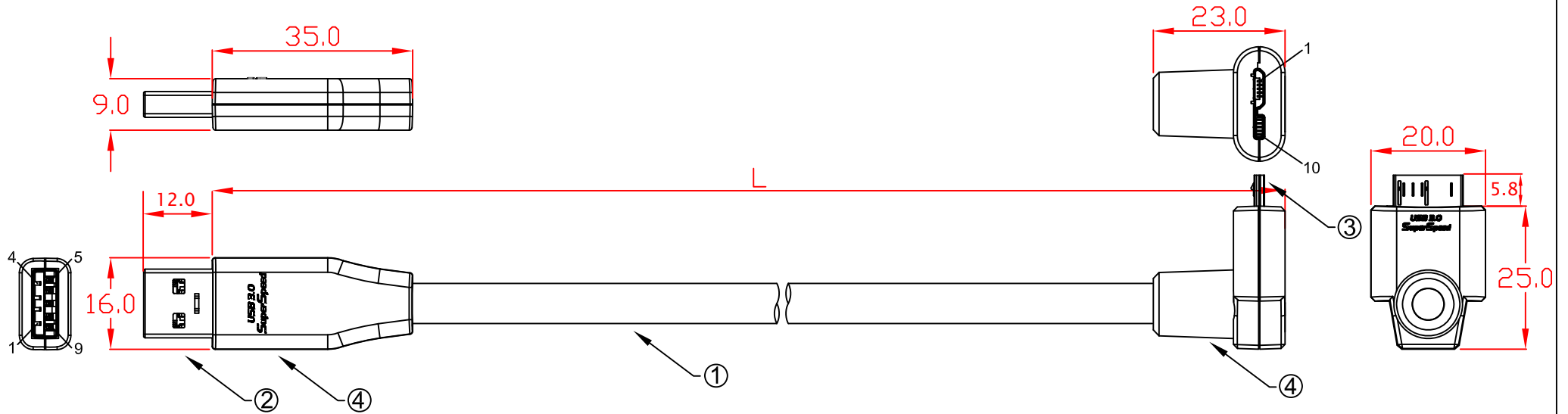

L:
 CBL-HFPD3igMB-1mUA 1000mm±20mm
 CBL-HFPD3igMB-2mUA 2000mm±20mm
 CBL-HFPD3igMB-3mUA 3000mm±20mm

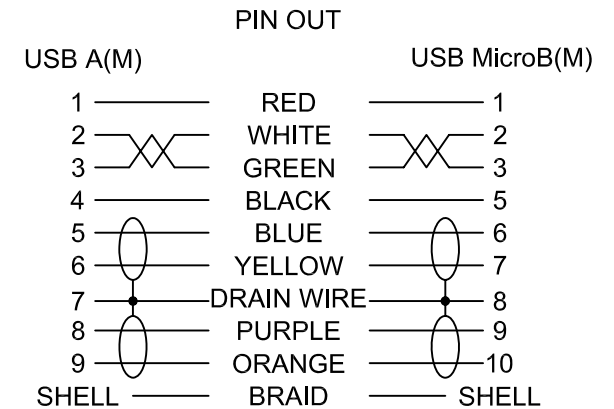

No	MATERIALS LIST:
1.	CABLE:UL20236 (2x(2x28AWG)+2x(2x28AWG)C) OD:7.0mm PUR JACKET COLOR:RED LILAC
2.	CONNECTOR:USB 3.0 A/M, 9P, BLUE INSULATOR SOLDER TYPE, NICKEL PLATED SHELL
3.	CONNECTOR:USB 3.0 MicroB/M, 10P, BLACK INSULATOR SOLDER TYPE, NICKEL PLATED SHELL
4.	ABS ASSEMBLY HOUSING, BLACK COLOR

Jargy part no.	Client part no.	Approved	SCALE	UNIT
CBL-HFPD3igMB-xmUA				mm
Drawing Name		Drawn	Date	REV.
USB 3.0 A to MicroB Cable M/M				1.0

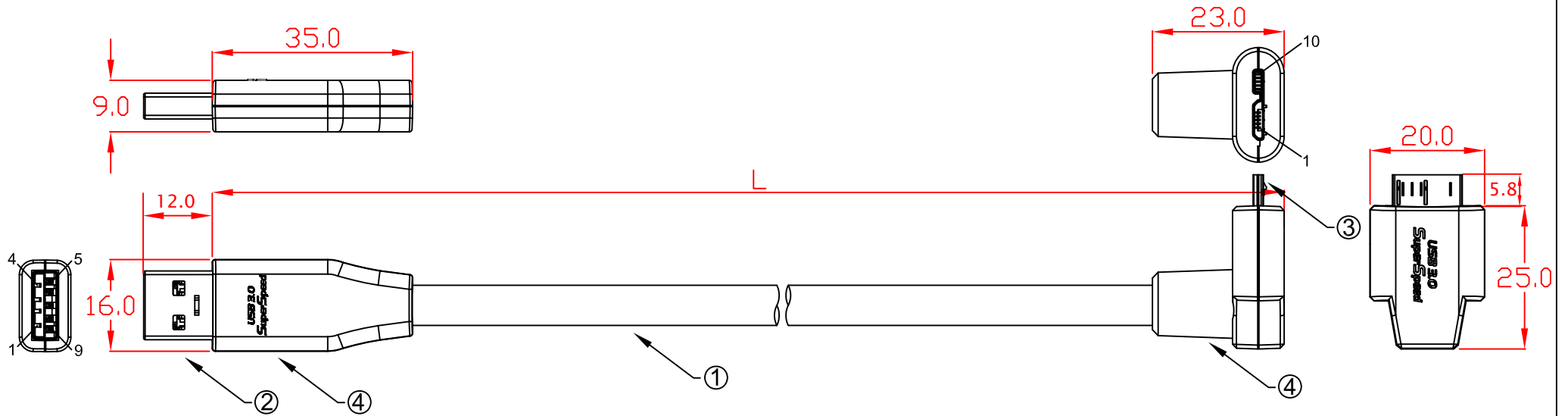

L:
 CBL-HFPD3igMB-1mDA 1000mm±20mm
 CBL-HFPD3igMB-2mDA 2000mm±20mm
 CBL-HFPD3igMB-3mDA 3000mm±20mm

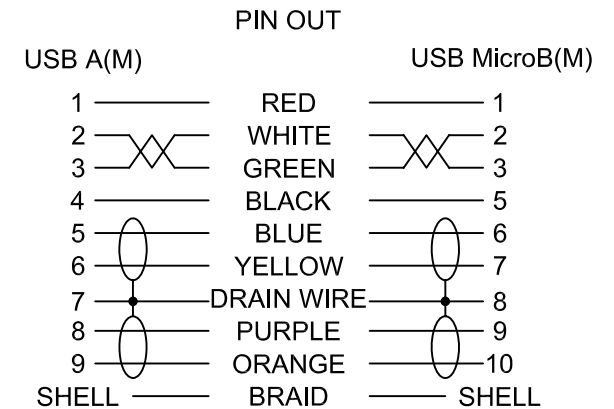

No	MATERIALS LIST:
1.	CABLE:UL20236 (2x(2x28AWG)+2x(2x28AWG)C) OD:7.0mm PUR JACKET COLOR:RED LILAC
2.	CONNECTOR:USB 3.0 A/M, 9P, BLUE INSULATOR SOLDER TYPE, NICKEL PLATED SHELL
3.	CONNECTOR:USB 3.0 MicroB/M, 10P, BLACK INSULATOR SOLDER TYPE, NICKEL PLATED SHELL
4.	ABS ASSEMBLY HOUSING, BLACK COLOR

Jargy part no.	Client part no.	Approved	SCALE	UNIT
CBL-HFPD3igMB-xmDA				mm
Drawing Name		Drawn	Date	REV.
USB 3.0 A to MicroB Cable M/M				1.0